



JT **AD** **SERIES**

All Electric Servo Drive Vertical Type Injection Molding Machine



JSW Hiroshima Plant

JSW



JSW Injection Molding Machinery Division

High Quality Compact Design.

JSW has produced a super-advanced all-electric vertical type injection molding machine - it is faster, more precise, and more compact.

The JT-AD series machines have been evolving to match the needs of today and beyond: They display high productivity on in-line assembly.

Using the advanced technologies that have been fostered for many years and are unique to JSW, we have achieved high-precision injection molding.

Compact body
Low table height and smaller foot print.

Facilities Performance

Productivity
Faster table rotation and mold open/close.

Faster Cycles

Molding quality
62 micro second high-speed servo control circuit that is among the fastest in the industry.

Algorithm Technology

Operability and visibility
Large 15-inch LCD color display.

Innovative & Friendly Operation

Handling a variety of products
Wide selection range of injection modules and injection capability, with flexible control.

Wide Range of Injection Units Performance



JT40RAD



JT70RAD

JT AD SERIES

All Electric Servo Drive Vertical Type Injection Molding Machine



Low-Profile and Compact Design

This compact machine is easy to operate and suitable for in-line configuration.

Space saving

The machine width and installation space have been greatly reduced, to make possible inclusion of the machine on the assembly line. JT40RAD has reduced machine width by 150 mm and installation space by 18%, when compared with conventional models.

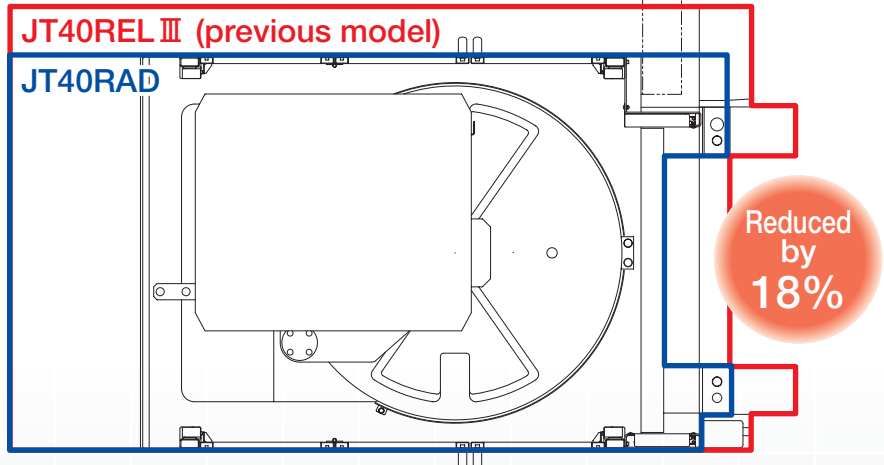

Larger molds

Although the machine width is more compact, the outer diameter of the table is the same as that of conventional models: Optimizing the nozzle position makes it possible to mount larger molds, and the machine can also handle larger, more complex dies, such as sliding cores.

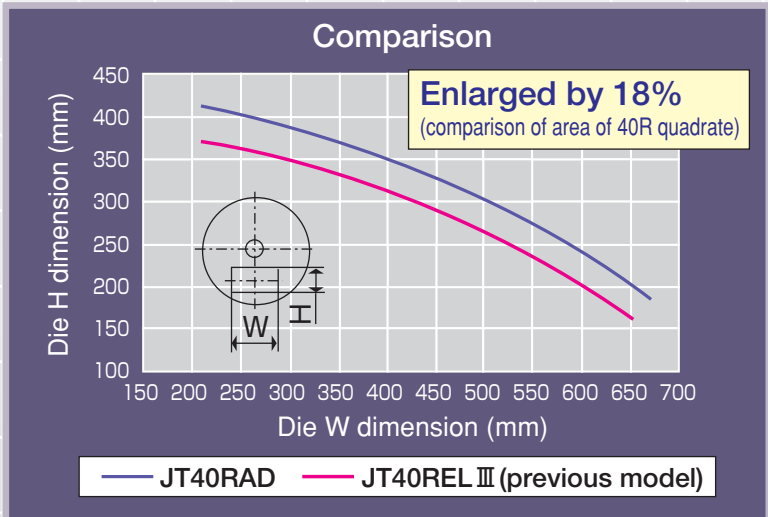

- Using new clamp design exclusively for the vertical machine has resulted in both table and overall height reduction.
- The use of dual control panel has reduced the machine width and footprint.
- Approaching a mold in 3+1 directions is standard, and the use of three-piece safety door improves operability and facilitates access to maintenance.

Compact table

The mold securing height has been reduced to allow the assembly line to be lowered, making it easier for the operator. With a JT40RAD-55V, the table height is 894 mm (35.2 inch), 146 mm (5.75 inch) lower than on conventional machines; the machine height of 2850 mm (112.2 inch) is the most compact in the industry (including mounting pads).

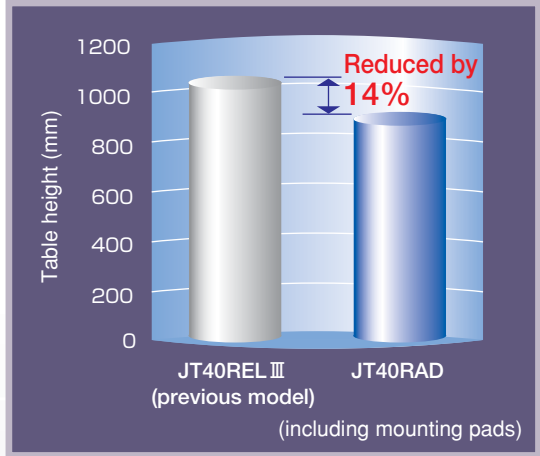
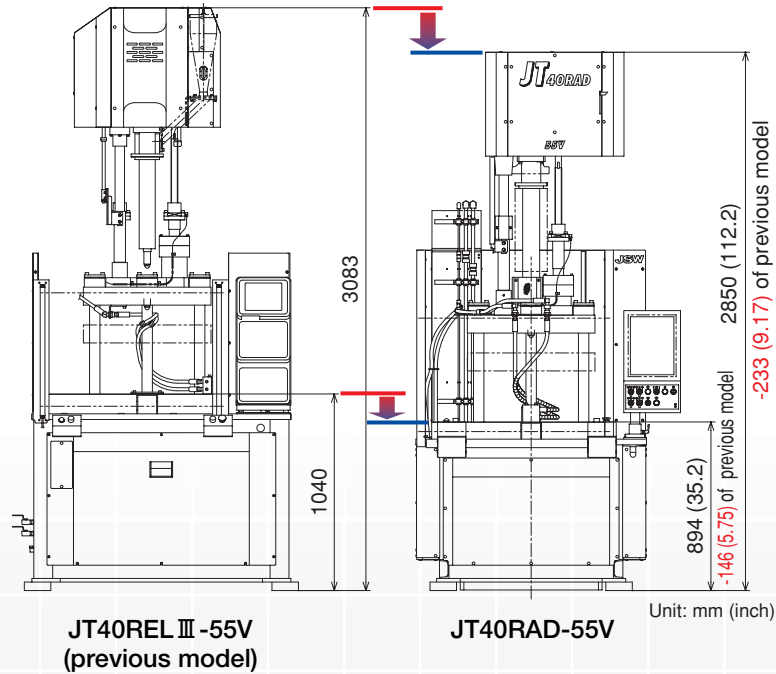

Mold accessible in three directions

A three-piece safety door is used: The door open/close area is smaller. This improves operability and ease of machine installation. A mold can be accessed from three directions - both sides of the machine and the operation side - and an open space is left on the opposite side from operation, so that a runner can be easily removed.



Faster Cycles

High-speed mold open/close and fast table rotation, improve productivity.

Faster cycles for mold open/close and rotary table rotation have been achieved.

High-speed clamp and smooth mold opening/closing are achieved by using a clamping mechanism exclusively for the vertical machine: This was designed to optimize the toggle link and reduce the weight of moving the clamp assembly. The table rotation control has been improved to achieve high-speed table rotation, thereby reducing lost time, and increasing productivity.

Fast, smooth mold open/close operation is ensured

A clamping mechanism exclusively for vertical machine with high-capacitance servo motor shortens the mold open/close dry cycle by 21% (JT40RAD). : This redesign results in high-speed, smooth mold open/close operation and facilitates high-cycle molding.

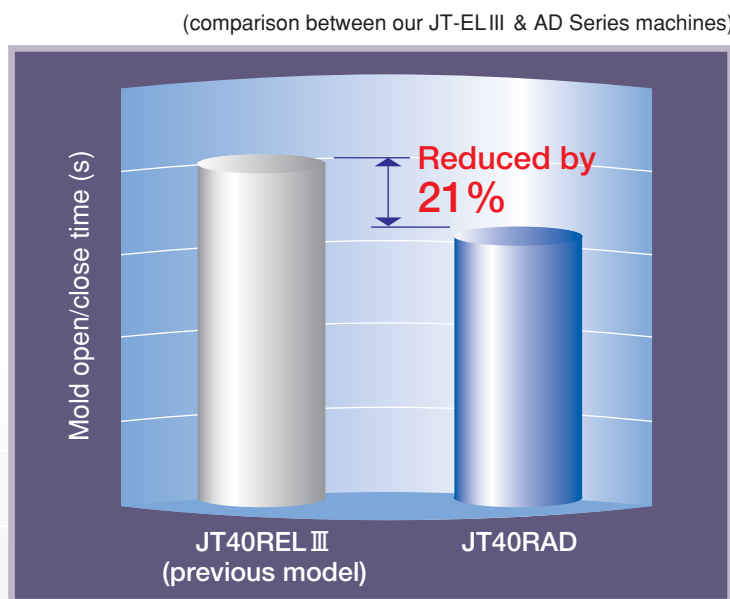

High-performance servo motor & timing belt

Silent, high-speed table rotation - the best in the industry - has been achieved by using a high-performance servo motor and timing belt. A mechanical stopper is provided at the rotation stop end to improve the stop accuracy during repetitive operation: This enables stable molding without any displacement of the inserted product. (The table rotates 180 deg. for reciprocated turning.)

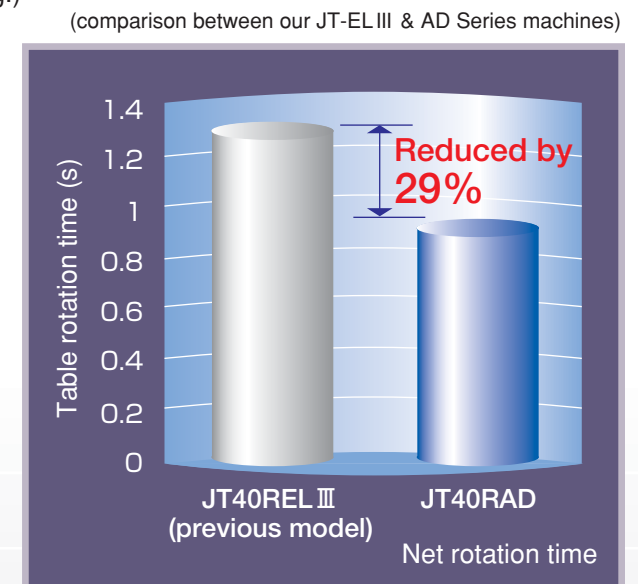
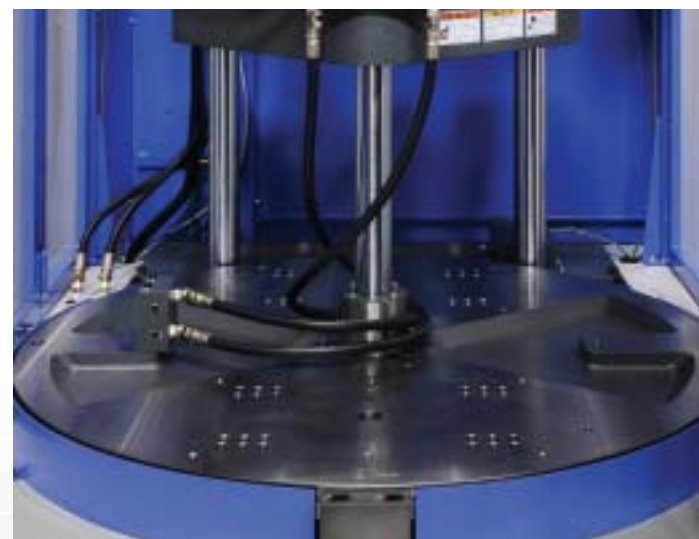

Injection compression makes a wide variety of molding possible.

The injection compression molding function, unique to JSW, is equipped as standard: The injection compression controls the position of mold with accuracy more than 10 times that of direct-pressure molding machines, making possible a wide variety of molding (PAT. 1744469).

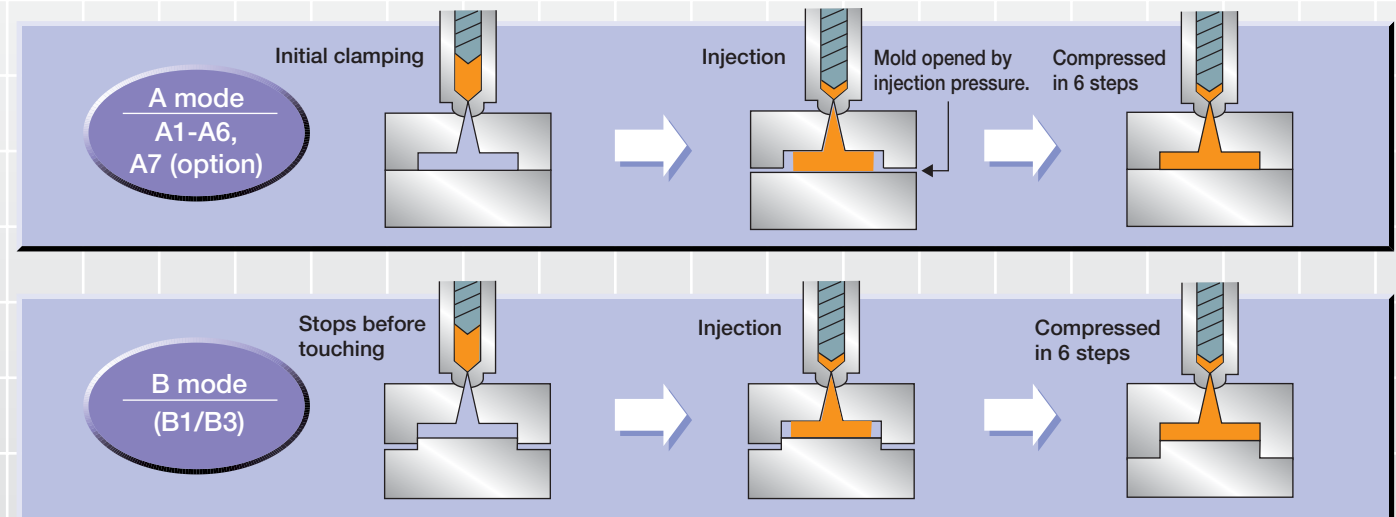
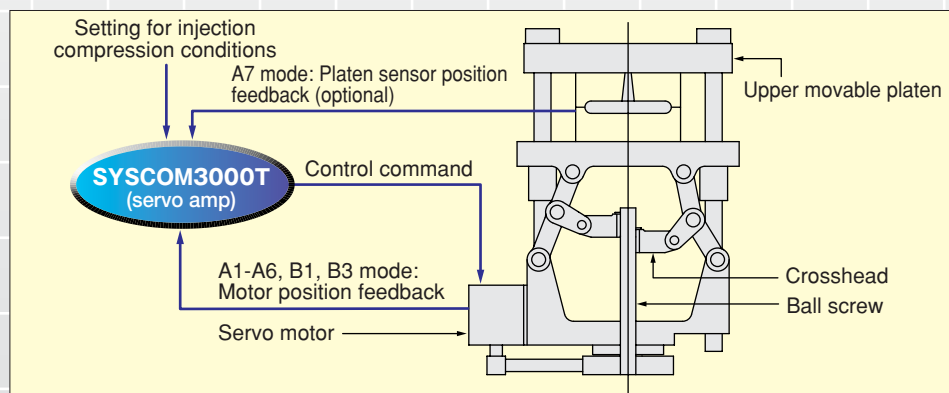



Algorithm Technology

62 micro second high-speed servo control circuit, the fastest in the industry, improves the product quality.



Large 15 inch LCD color monitor
Remarkably improved operability and visibility



Innovative & Friendly Operation

The marvelous 62 micro second high-speed servo control circuit results in both high precision and stable quality.

Upgraded SYSCOM3000T.

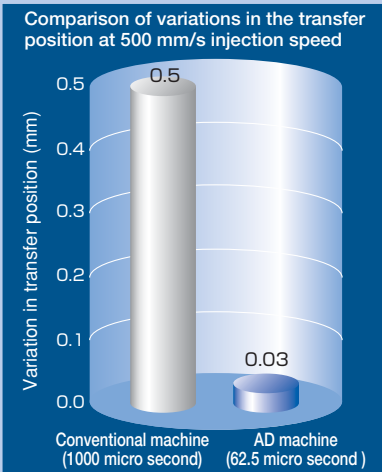

Use of 62 micro second high-speed servo control circuit in the "JT-AD Series" reduces scanning time to 1/16th of conventional controls. It promotes product quality through a reduction in performance variation, such as holding transfer pressures.



JSW original high-speed servo control board

Variation in the holding transfer pressure (comparison between our JT-EL III & AD Series machines)

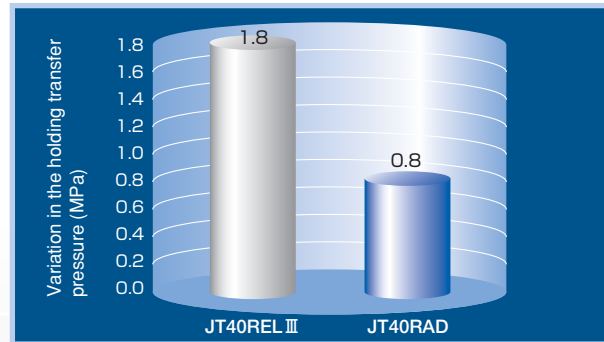

Molding machines: JT40REL III (conventional machine) vs JT40RAD-55V
Molded product: Electronic parts
Resin: PA 6

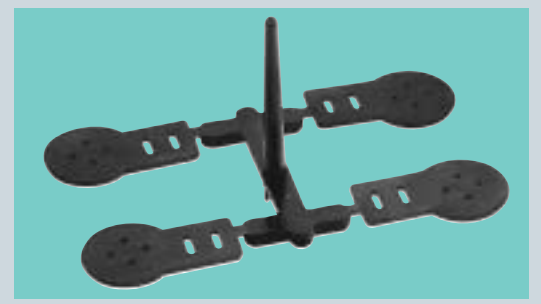

The resolution of injection pressure detector has been greatly improved.

The resolution of the load cell amplifier for the injection pressure has been intensified five times for more accurate injection, holding and back pressure control which helps insure stabilized precision molding.

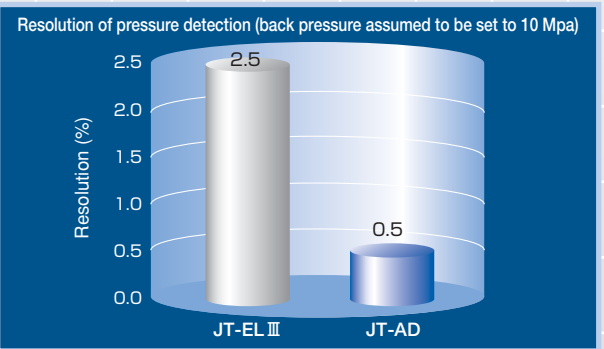

Variation in cushion (comparison between our JT-EL III & AD Series machines)

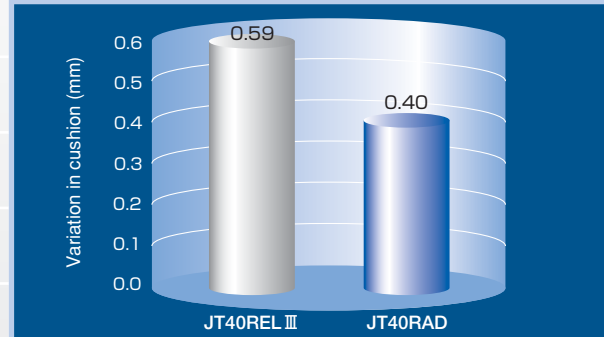

Variation in product weight (comparison between our JT-EL III & AD Series machines)

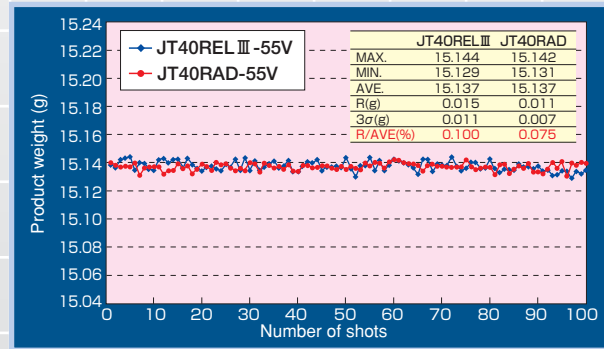

- A vertically arranged large 15 inch TFT color LCD screen. The controller rotates to provide the operator with a clear view of molding parameters.
- An illustration of the machine and a touch screen insures easy operation.
- The independent injection conditions can be set to conform the delicate difference between two lower molds. (Rotary type specification)
- Languages are selectable from English, Chinese and Japanese even during running. Other languages (Korean and Spanish) are optional.
- Up to 120 molding conditions can be stored in internal memory; up to 1,000 conditions can be stored in external memory (USB memory).



SYSCOM3000T screens

A controller consists of the condition setting screen, mode keys screen and operation switches.

Condition setting screen

Touch panel screen

Selector switches

③ Condition setting screens

① Cycle monitor screen

Injection	Core	USB-400
Cycle	0.00 s	Screw
INJ time	0.00 s	Plates
ROJ time	0.00 s	Ejector
INJ back P	0.00 MPa	Cushion
SP back P	0.00 MPa	HP end
ROJ time	0.00 s	Barrel R
		Screw Spd
		Trans Pos
		Trans Pos
		Trans Spd
		Latbid

② Convenient monitoring screens



Wide Range of Injection Units Performance

A wide selection of injection units with versatile control modes promotes the product quality.

Module system

The low inertial injection (HR) specifications (*optional) and high-speed, high response injection (HS) specifications (*optional) have been added on the module system that is highly accepted in the industry. The module system enables selection of opportune injection unit and covers diversified products including micro and thin-walled molding.

Module system

Single acting type	M40	M70	M100	Clamping module
20V	○			The single acting type is under preparation.
55V	○	○	○	
110V	○	○	○	
230V				
Injection module				

Rotary type	M20R	M40R	M70R	M100R	M150R	Clamping module
20V	○	○				Models marked * are under preparation
55V	○	○	○	○	○	
110V	○	○	○	○	○	
230V	○	○	○	○	○	
Injection module						

Note: High-speed, high-response injection (HS) specification applies to the injection unit marked ○.

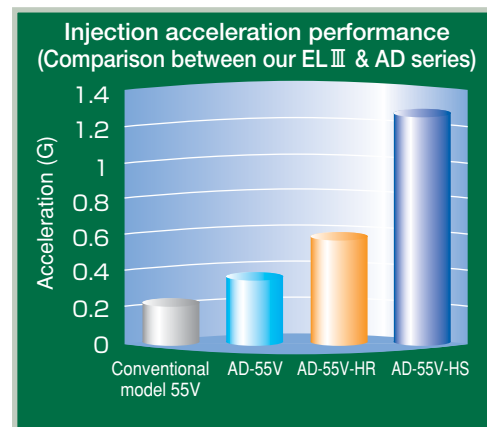

JSW's unique injection control

IWCS (Injection Weight and Cushion Stability) control

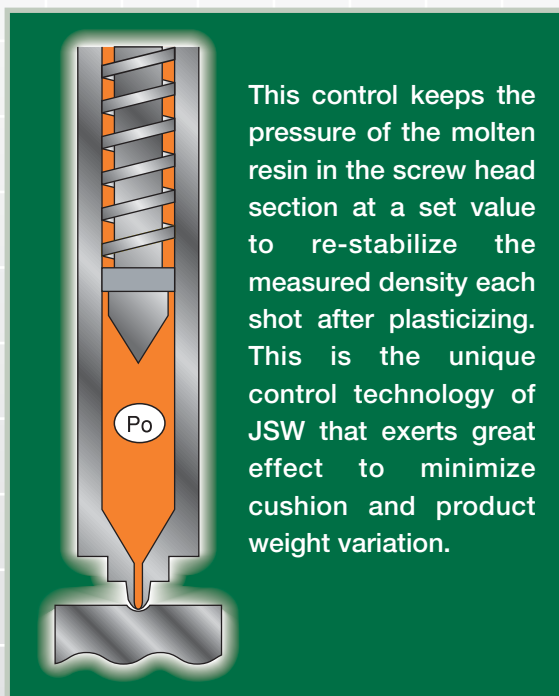

This control keeps the pressure of the molten resin in the screw head section at a set value to re-stabilize the measured density each shot after plasticizing. This is the unique control technology of JSW that exerts great effect to minimize cushion and product weight variation.

This JSW's unique function effectively stabilizes cushion and product weight fluctuation. (PAT. # 3529771)

Effect of reduced cushion variation

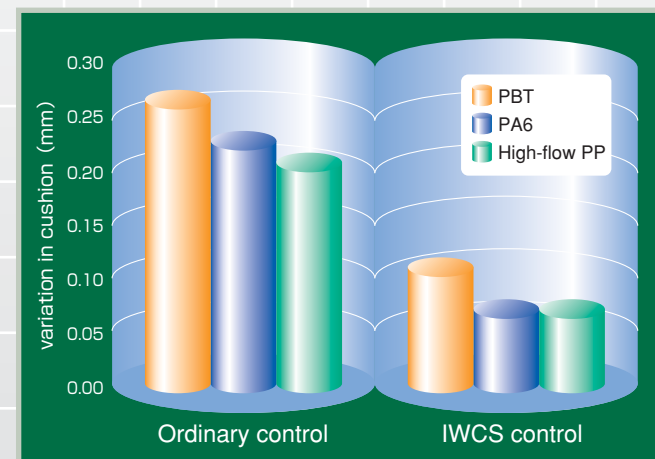

Electric-driven soft-pack servo control

This JSW unique control technology suppresses peak pressure immediately before switching the holding pressure in the injection process, keeping the machine pack at optimum pressure. It results in over-pack prevention in thin-wall molding. (PAT. # 1755568)

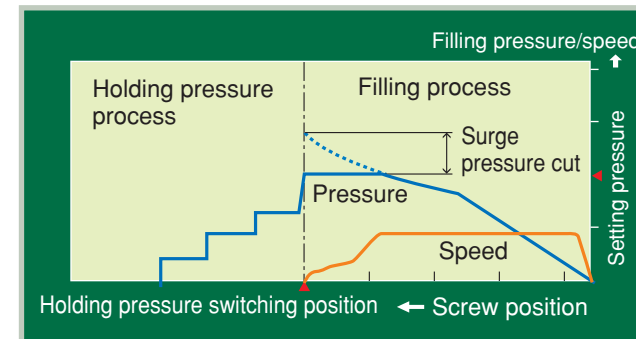

Effects of soft-pack servo

- Molding distortion reduced
- Burrs cleared
- Dispersion in weight of molded products reduced
- Clamping force reduced (low-pressure molding)
- Mold-friendly

APC (Advanced Pressure Control)

This JSW unique control technology suppresses overshoots or undershoots of resin pressure during the filling/holding pressure process, a dramatic upgrade of the tracking and responsibility for setting pressure. (PAT. # 3168289)

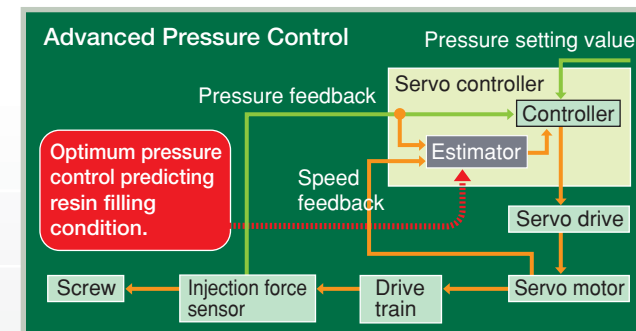

Holding pressure force characteristics

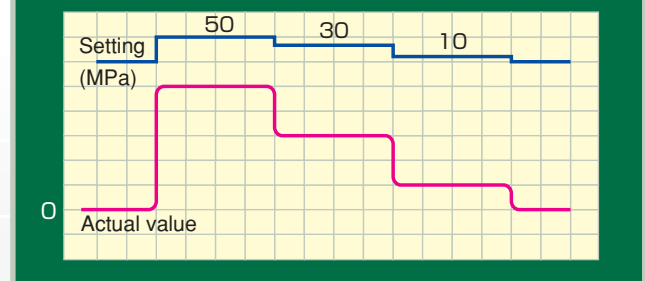

Predicted control of metering

To ensure smooth stops with optimum screw rotation and back pressure load at the screw rotation completion position, estimate control is located in the front of the screw rotation completion position: The screw rotation number can be reduced to the optimum without any loss in time, and back pressure can be decreased.

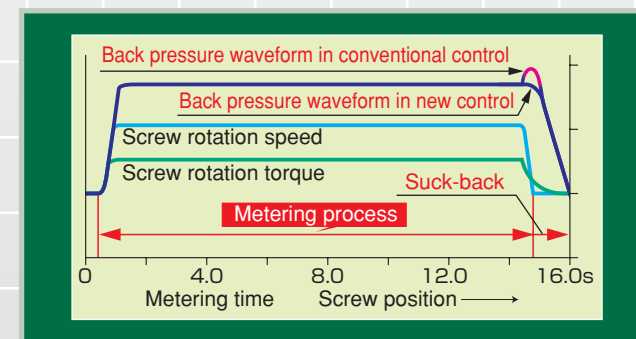

Before-holding pressure deceleration control

This control uses the estimate control to reduce the speed to the optimum holding pressure speed, from its position before the holding pressure transfer position: This decreases the inertia that is peculiar to electric injection molding machines and improves stability in holding pressure transfer pressure, which is essential for precision molding.

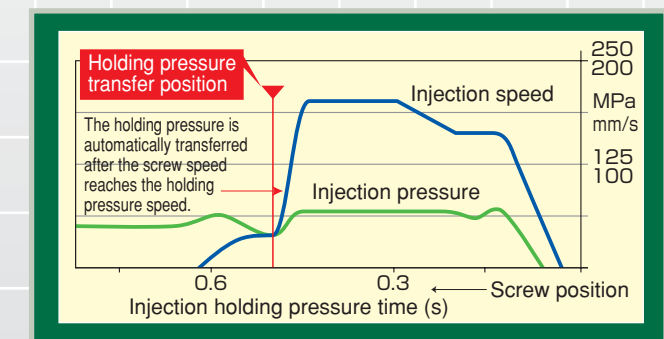

List of standard accessories

Item	
Injection/plasticizing	KC nozzle (tip type)
	N2000F barrel (corrosion/abrasion resistance type) Note 1
	LSP-2 screw (abrasion resistance type) Note 1
	HT screw head
	Screw suck-back
	Screw and barrel attachment/detachment device
	Screw cold start prevention
	Molding/Pause temperature select
	Automatic purging circuit
	Nozzle touch force remote setting
	Nozzle retract select
	Suck-back select
	Automatic greasing
	Injection/Metering programmed control
	Injection/holding pressure: 1 to 6 steps (variable) Metering/back pressure: 1 to 3 steps (variable)
	Holding pressure transfer by speed detection (IVS control)
	Barrel temperature remote setting
	Barrel temperature control (SSR)
	Soft-pack servo control
	Hopper flange temperature control
IWCS control	
Reverse seal control	
Holding pressure control select	
Synchronous temperature rise control	
Grease-free toggle bushing	
Automatic greasing	
Mold open/close and ejection programmed control	
Mold open/close: 4 steps (fixed) Ejection: 1 to 3 steps (variable)	
Electric-driven mold thickness adjusting device	
Mold thickness remote setting	
Auto clamping force setting	
Toggle type injection compression function	
A-mode B-mode Compression: 1 to 6 steps (variable)	
Mold protection function	
Photoelectric safety device (rotary type only)	
Table speed remote setting (rotary type only)	
Clamping safety device (electric/double mechanical type) Note 2	
Robot mounting holes	

Note 1: One set of K or A size screws is equipped in standard. B size is optional.
 Note 2: Photoelectric type is used for operation side of rotary type.
 Note 3: The external memory can store up to 1000 mold conditions. Prepare commercial USB data storage media.
 Note 4: Printer and printer cable are optional.

Item	
Controller	Touch-panel TFT color LCD controller
	Molding condition storage (internal memory: 120 molds) Note 3
	Lower two-die molding condition auto switching (rotary type only)
	USB printer port Note 4
	Self-diagnosis function
	Overall setting screen
	Help function
	Pre-heat timer
	Compound action
	Clock
Monitor	Attended/unattended operation select
	Multi-language select (English/Chinese/Japanese)
	Barrel temperature monitor
	Heater system fault
	Injection pressure monitor (IPM)
	Injection/metering waveform monitor
	Injection/metering waveform storage
	Oscilloscope waveform monitor
	Injection pressure overshoot alarm
	Statistical graph
	Measurement value display
	Mold temperature display Note 5
	Grease lubrication fault alarm
	Fault alarm buzzer
	Production monitor
	Cumulative operating hour display
	Cycle monitor
Molding condition upper/lower limit monitor Note 6	
Inspection and maintenance Note 7	
Alarm history	
Set value history	
Servo fault alarm	
Others	Cooling water closed circuit
	Accessories (maintenance tools, ejector rods)

Note 5: Thermal sensor and electric wiring are not included.
 Note 6: A maximum of 8 items and alarms can be selected out of the following monitor items.
 ① Cycle time ② Injection time ③ Metering time
 ④ Cushion position ⑤ Holding pressure end position
 ⑥ Injection pressure ⑦ Holding pressure transfer pressure
 ⑧ Screw back pressure ⑨ Metering end position
 ⑩ Injection start position ⑪ Holding pressure transfer position
 ⑫ Mold open time ⑬ Mold close time ⑭ Metering torque
 ⑮ Holding pressure transfer speed ⑯ Mold inner pressure <option>
 Note 7: Indicates inspection time and items.

■ KC nozzle



■ N2000F barrel



■ LSP-2 screw



■ HT screw head



■ Clamping safety device



● Photoelectric safety



● Mechanical safety
① Pulley stopper



● Mechanical safety
② Safety bar

List of optional accessories

Item	
Injection	Long nozzle
	Shut-off nozzle (pneumatic type)
	Hi-Melta MII screw Note 1
	Ultra corrosion/abrasion resistance screw barrel Note 2
	B size screw barrel
	Hopper throat abrasion resistance sleeve
	Barrel insulation cover
	Hopper
	Hopper attachment tube
	Ceramic screw head
	PCD screw head
	Module 1 rank down sized barrel
	Residual resin alarm
	Low inertial injection (HR)
	High-speed/high-response injection (HS)
Clamping	Vent-type injection device Note 3
	Daylight extension
	Thermal insulation plate for platens Note 4
	Air jet
	Core pull circuit (pneumatic type, hydraulic type) Note 5
	Unscrewing motor circuit
	Die clamper
	Upper-die ejector (hydraulic type) Note 5
	Ejector 3-point ejection (rotary type only)
	Ejector stroke extension (rotary machine only)
Mold temperature control piping (for high-temperature, rotary type only)	
Mold setup device (inside platen, outside platen) Note 6	
Mold one-direction access (270 deg. rotation, rotary type only)	
Mold clamper	

Note 1: Applied for screw diameters of 35 mm or more.
 Note 2: Consult us individually for specifications.
 Note 3: Screw diameters of 25 mm or more are compatible.
 Note 4: If an insulation board is equipped, note that both the nozzle stroke and the range of mold thickness used will be changed.
 Note 5: Pump unit is separately required for the hydraulic type.
 Note 6: When inside platen access device is equipped, the ejector stroke extension (option) is required.
 Note 7: Consult us separately for languages other than the above. English and Chinese are provided standard.
 Note 8: LINK10 has measurement value data collection, molding condition management and remote console functions.
 Note 9: The NET100 has quality control and production control functions in addition to the functions of LINK10.
 Note 10: For export specifications, separate meetings may be necessary depending on the destination.
 Note 11: Designated colors, referring to color samples or Munsell codes.

Item	
Electric installation/control	Other language select (Korean/Spanish) Note 7
	Simple centralized monitoring system LINK10 Note 8
	Centralized management system NET100 Note 9
	Heater disconnection alarm
	Mold temperature display (with mold temperature upper/lower limit alarm)
Others	Mold temperature control device (heater type)
	Printer (with printer cable)
	Robot interface
	Cooling water flow indicator
	Cooling water failure warning
	Leveling pads for installation
	Rotary warning light
	Export specifications Note 10
	Designated color Note 11

Examples of attaching optional devices



● External appearance and specifications of this machine are subject to change without notice to make improvements.
 ● Unauthorized reprint from this catalog is prohibited.
 ● Photos shown in this catalog include those of optional devices.

JSW THE JAPAN STEEL WORKS, LTD.

URL <http://www.jsw.co.jp/>

Division J-Tower, 1-1, Nikko-cho, Fuchu-shi, Tokyo 183-8503, Japan
Head Quarter: Phone: +81-42-330-8008 Fax: +81-42-330-8023
URL http://www.jsw.co.jp/inj_f/inj_index.htm

JSW Plastics Machinery, Inc.

Head Office: 555 South Promenade Ave., Unit 104, Corona, California 92879, U.S.A.
Phone: +1-951-898-0934 Fax: +1-951-898-0944
Chicago Office: 1300 Landmeier Rd., Elk Grove Village, Illinois 60007, U.S.A.
Phone: +1-847-427-1100 Fax: +1-847-427-1121
Detroit Office: 24404 Catherine Industrial Drive, Suite 310 NOVI, Michigan 48375, U.S.A.
Phone: +1-248-449-5422 Fax: +1-248-449-6018
Atlanta Office: 1700 Cumberland Point Drive, Suite 17, Marietta, Georgia 30067, U.S.A.
Phone: +1-770-952-0269 Fax: +1-770-956-9058

JSW Plastics Machinery (S) Pte Ltd

Head Office: 17, Gul Lane, Jurong Town, Singapore 629413, Republic of Singapore
Phone: +65-68614511 Fax: +65-68623166
Philippine Office: Chemdis Bldg., Don Jesus Blvd., Alabang Hills Village, Muntinlupa City, Philippines
Phone: +63-2-809-8982 Fax: +63-2-809-6221
Indonesia Office: Jl. Palatehan Raya No.1-A, Kebayoran Baru, Jakarta 12160, Indonesia
Phone: +62-21-725-7486 Fax: +62-21-725-7865

JSW Plastics Machinery (M) SDN. BHD.

No.42, Jalan PJS 11/7, Bandar Sunway, 46150 Petaling Jaya,
Selangor Darul Ehsan, Malaysia
Phone: +60-3-56356453 Fax: +60-3-56356542

JSW Plastics Machinery (T) Co., Ltd.

368/4, Soi Soonvijai 4, Rama IX Road, Bangkok, Huaykwang,
Bangkok 10310, Thailand
Phone: +66-2-369-4007 Fax: +66-2-369-4035

JSW Plastics Machinery Vietnam Ltd.

Room 103, Techno-Center Thang Long Industrial Park Dong Anh District,
Hanoi, Viet Nam
Phone: +84-4-951-6383 Fax: +84-4-951-6384

JSW Plastics Machinery (H.K.) Co., Ltd.

Room 907, Corporation Park, 11 On Lai Street, Shatin N.T., Hong Kong
Phone: +852-2648-0720 Fax: +852-2686-8204

JSW Injection Machine Maintenance (Shenzhen) Co., Ltd.

901, East, Dingxin Bldg., West Shahe Road,
Nanshan District, Shenzhen, 518055, People's Republic of China
Phone: +86-755-8602-0930 Fax: +86-755-8602-0934

JSW Plastics Machinery (Shanghai) Corp.

29-D, Strength Plaza, No.600-3, Tianshan Road, Shanghai, 200051,
People's Republic of China
Phone: +86-21-5206-7031 Fax: +86-21-5206-7033

JSW Plastics Machinery (TAIWAN) Corp.

Head Office: 1F., No.23, Da Hu 1st Rd., Guishan Shiang Taoyuan, Taiwan, R.O.C.
Phone: +886-3-396-2102 Fax: +886-3-396-2104
Tainan Office: 15 F-7, No.689-78, Shiau E. Rd., Yungkuang City, Tainan, Taiwan, R.O.C.
Phone: +886-6-311-4192 Fax: +886-6-311-4193

